

ELNUR GABARRON[®]

INSTRUCCIONES DE USO
USER OPERATING INSTRUCTIONS



ACUMULADOR DE CALOR INTELIGENTE

SMART STORAGE HEATER

ECOMBI PRO

MODELOS / MODELS

ECO15 PRO

ECO20 PRO

ECO30 PRO

ECO40 PRO



*Por favor, lea estas instrucciones atentamente antes de instalar o utilizar el aparato por primera vez.
Please read these instructions carefully before installing or using this appliance for the first time.*

I. -IMPORTANT INFORMATION

When using electrical appliances, basic precautions should always be followed to reduce the risk of fire, electric shock, and injury to persons, including the following:

- Keep combustible materials, such as furniture, pillows, bedding, papers, clothes, etc. and curtains at least a foot (30cm) from the front, sides and rear of the heater. It is essential that the indicated minimum clearances are maintained.
- **CAUTION** — Some parts of this product can become very hot and cause burns. Particular attention must be given where children and vulnerable people are present.
- This appliance can be used by children aged from 8 years and above and persons with reduced physical, sensory or mental capabilities or lack of experience and knowledge if they have been given supervision or instruction concerning the use of the appliance in a safe way and understand the hazards involved. Children must not play with the appliance. Cleaning and user maintenance must not be made by children without supervision.
- Children aged from 3 years and less than 8 years shall only switch on/off the appliance provided that it has been placed or installed in its intended normal operating position and they have been given supervision or instruction concerning use of the appliance in a safe way and understand the hazards involved. Children aged from 3 years and less than 8 years shall not plug in, regulate and clean the appliance or perform user maintenance.
- Children of less than 3 years should be kept away unless continuously supervised.
- Do not operate any heater after it malfunctions. Disconnect power at service panel and have heater inspected by a reputable electrician before reusing. To disconnect heater, turn controls to off, and turn off power to heater circuit at main disconnect panel.
- Do not insert or allow foreign objects to enter any ventilation or exhaust opening as this may cause an electric shock or fire or damage the heater.
- Do not use this heater to dry clothes. To prevent a possible fire, do not block air intakes or exhaust in any manner. Air inlets and outlets provide proper operation of the appliance and prevent its overheating. **DO NOT** cover air inlet and outlet grills.
- A heater has hot and arcing or sparking parts inside. Do not use in areas where gasoline, paint, or flammable vapors or liquids are used or stored. The use of these heaters is forbidden in any area where there is a presence of gases, explosives or inflammable objects. Never open a charged heater.
- **SAVE THESE INSTRUCTIONS.** This guide must be kept and given to any new user. Use this heater only as described in this manual. Any other use not recommended by the manufacturer may cause fire, electric shock, or injury to persons. The warranty of the heater will not cover any damage caused by non observance of any of these instructions.
- Do not use this heater outdoors.

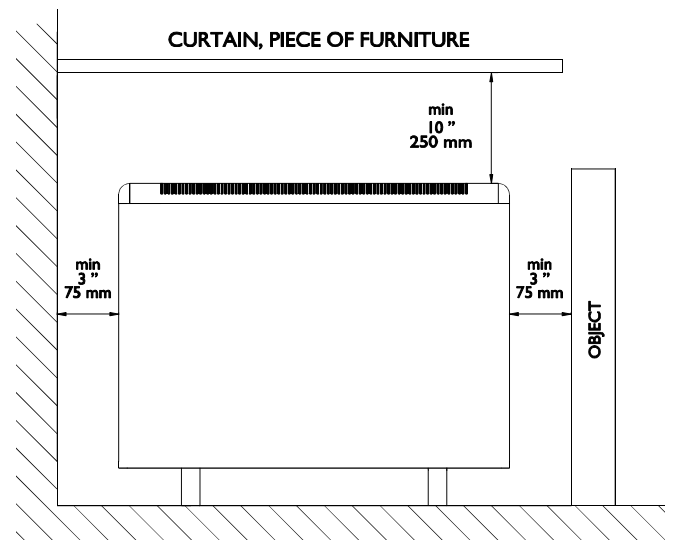

WARNING: In order to avoid overheating do not cover the heater.

2. - OPERATING INSTRUCTIONS

2.1. General information



CAUTION: DO NOT USE THIS HEATER TO DRY CLOTHES. Do not cover this heater at any time.

CONNECTION / DISCONNECTION

Power switch. All models are equipped with a switch on the back side panel. It is used to connect and disconnect ECOMBI PRO.



KEYBOARD:



Keep pressed the button to access the advanced configuration. Press this button to go back in the different menus.



Press the button to confirm values in the different menus.



Press the key to increase the displayed value or to advance through the different options available.



Press the key to decrease the displayed value or to move through the different options available.

ON/OFF



Once the heater is connected to a main supply you can turn the heater ON by switching the main ON/OFF switch positioned at the rear right side of the heater as shown above.



BACKLIGHT

Pressing any button, the display will illuminate with a soft white colour. After certain time if no buttons are pressed the display backlight will turn off.

Buttons only will respond when the backlight is on.

KEYBOARD LOCK

During any operation mode, it is possible to lock the keyboard by holding  and  simultaneously for 5 seconds. A pop-up window will confirm the keyboard lock.

To unlock the keyboard, press  and  simultaneously for 5 seconds. A pop-up window will confirm the keyboard unlock.

2.2. Commissioning

An easy installation wizard is programmed in Ecombi PRO electronic control. Follow the start wizard instructions when turning your Ecombi PRO on for the first time or after resetting it to the factory settings.

START WIZARD - INITIAL SETTINGS.

The Ecombi PRO electronic control will guide you through the commissioning of the unit. The steps to follow are:

a. Select language. Confirm the language in the storage heater electronic control.

b. Date & Time. Check and confirm that the default date & time in the unit is correct. If not, please change it.

c. Charging periods. 2 different charging periods can be set in Ecombi PRO. Set Charging Periods 1 & 2 according to your electricity low tariff hours.

By default, Ecombi PRO is set to an 8 hours charging period, from 00:00 to 08:00 hours. If this charging time matches your electricity low tariff hours, you do not need to make any changes in the unit configuration. Otherwise, you can change charging Periods 1 and 2 to match your electricity tariff.

If your electricity tariff is 14 hours off-peak, you must modify the charging configuration in the advance settings menu and select 14 hours nominal charging period.

d. Temperature setting. This is the last step of the start wizard. Select and confirm the room set temperature of your choice.



With the help of the start wizard, you will set you Ecombi PRO storage heater for an automatic operation. It will charge and store the heat during the charging hours set in c.Charging Periods and it will adjust the charge level and consumption according to the set temperature of your choice.





An incorrect time, charging periods or set temperatures configuration, might result in a high cost of the electricity bill.

3.- ADVANCED SETTINGS

With the general settings menu, you can make additional changes and adjustments in device start-up and operation. To access the settings menu of the device, press and hold the  button for 5 seconds in the home screen of any operating mode of the device with the screen lit. The following screen appears:





Use  or  to move up and down. Confirm with  to enter the desired setting.

3.1. Operating mode

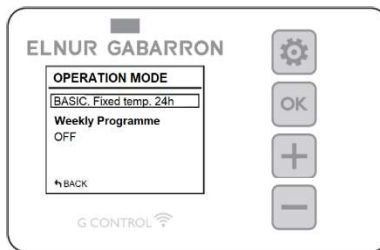
Scroll down to Operating Mode and press  to access the operating mode selection menu. A new screen will appear with the selectable operating modes:



- **Basic mode or 24-hour temperature mode:** The storage heater retains the setpoint temperature for 24 hours. In this mode, the device automatically regulates and adjusts its charge day by day in order to maintain the temperature selected with minimum expense. To change the basic mode setpoint temperature value, simply press  or  when the device is operating in this mode until the desired temperature is displayed. The setpoint temperature and the charge level are displayed on the screen in this mode.



ADJUST SETPOINT TEMPERATURE

- **Weekly programme:** The setpoint temperature varies in accordance with the weekly programme set in the unit. 3 temperature levels (Comfort, Eco and Frost Protection) can be selected for each time interval (1 hour) in order to adjust the temperature of the room to the habits and needs of the different users. You can alter the setpoint temperature of each of the 3 temperature levels (See section 3.3.1 **Temperatures. Edit Programme**) as well as the corresponding temperature level at each hour of the week. (See section 3.3.2 **Weekly programme. Edit programme**). The horizontal temperature display for the 24 hours of the current day appears on the screen together with the setpoint temperature of the current period.

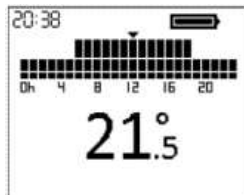

- **Off:** The storage heater does not retain any temperature or follow any programming, as it retains the time setting previously set. The compensation element will be activated if the room temperature is below the Frost Protection in order to prevent freezing. The set point temperature (3°C) and the Frost Protection message appear on the screen.















3.2. Date and time

You can see the device time at any time in the top left corner of the screen. The date can be seen in the “Date and Time” menu.

To change the time or the date, access the advanced settings menu by pressing  for 5 seconds and then access the “Date and Time” menu. The Date and Time menu will allow you to change the following values:

DATE & TIME	
DATE	01/01/2020
TIME	22:00
DATE FORMAT	
TIME FORMAT	
←BACK	

- **Date:** Use  or  to select the desired day/month/year. Confirm with .
- **Time:** Use  or  to select the desired hour/minute. Confirm with .
- **Date format:** Use  or  to select the desired format. Confirm with .
- **Time format:** Use  or  to select the desired format. Confirm with .

 If the device is connected to a G Control hub, the time setting is overridden and the hub time is set automatically. In this case, the time set menu will not be accessible.

 The Ecombi PRO automatically changes the time from wintertime to summertime and vice-versa, even if it is not connected to the G Control hub, provided that the Automatic Time Change parameter is activated. (Activated by factory setting).

3.3. Programme Settings

This menu will only be accessible when the device is operating in the operating mode **Weekly Programme**. In this menu, you can change the comfort, eco and frost protection temperatures and select or change the existing weekly programming.

To do this, access the advanced settings menu by pressing  for 5 seconds and then go into the “Programme settings” menu.



PROGRAMME SETTINGS
TEMPERATURES
WEEKLY PROGRAMME
←BACK

3.3.1. Temperatures. Programme Settings

You can change the setpoint temperature value of the 3 temperature levels used in the Programme Mode (Comfort, Eco and Frost Protection) at any time.

TEMPERATURES	COMFORT	ECO	ANTI-FROST
COMFORT 21.5° ECO 18.0° ANTI-FROST 7° ←BACK	21.5°	18°	7°

To do this, access the “Temperatures” menu and change “Comfort”, “Eco” or “Frost Protection” as you wish. Press  to exit the home menu.

 It is possible to change the setpoint temperature temporarily in the home screen during the current period of the programme mode. You can do this by simply pressing the  or  buttons. The temporary change is retained until the next change of programmed period.

3.3.2. Weekly Programme. Programme Settings.

In the “Weekly Programme” menu you can select from one of the 3 predefined programmes or you can edit the existing programme from the “Weekly Programme” menu in order to set a customised programme.

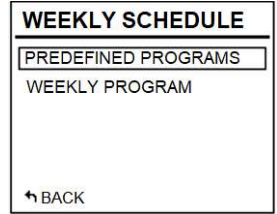

3.3.2.1. PREDEFINED PROGRAMMES

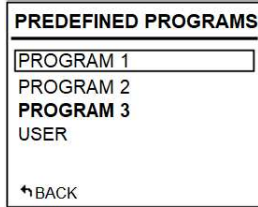

The selected option will be highlighted in bold.

The option "USER" will only appear, in case a personalized programming has been previously saved.

In this section you have the option of selecting one of the 3 operating programmes preset in the device.

Programme 1 (At home)

Monday to Sunday:

- 00:00 - 07:00 Eco (☾)
- 07:00 - 22:00 Comfort (☀)
- 22:00 - 00:00 Eco (☾)

Programme 2 (Work M-F)

Monday to Friday:

- 00:00 - 07:00 Eco (☾)
- 07:00 - 08:00 Comfort (☀)
- 08:00 - 17:00 Eco (☾)
- 17:00 - 22:00 Comfort (☀)
- 22:00 - 00:00 Eco (☾)

Saturdays and Sundays:

- 00:00 - 07:00 Eco (☾)
- 07:00 - 22:00 Comfort (☀)
- 22.30 - 00:00 Eco (☾)

Programme 3 (Office hours)



Monday to Sunday:

- 00:00 - 07:00 Eco (☾)
- 07:00 - 18:00 Comfort (☀)
- 18:00 - 00:00 Eco (☾)

3.3.2.2. WEEKLY PROGRAMME:

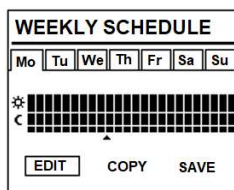
If you do not want to use any of the factory preset programmes, you can set a customised programme from the “Weekly Programme” menu.





To do this, scroll down to the day that you want to programme and press . Select “Edit” and press  to programme the day selected.

The first segment of the day of the week corresponding to the period 00:00 → 01:00 starts to flash. The bar diagram at the top part of the screen represents the temperature levels programmed for each hourly period of the day in question.

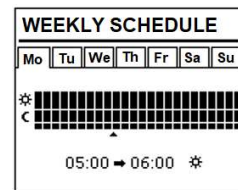
- 3 bars represent the hourly period with comfort temperature programmed. (☼)
- 2 bars represent the hourly period with eco temperature programmed. (☾)
- 1 bar represents the hourly period with frost protection temperature programmed. (☾)



By pressing  you can select the desired temperature level for the current hourly period: Frost Protection ☼, Economy ☾ or Comfort ☼.

Press  to go to the next hour. When you have set the different hourly periods for the day selected, press  and the setting for this day will be recorded.

COPY THE DAILY PROGRAMME, GO TO THE NEXT DAY

You can **copy** the programme of the current day to the other days of the week. To do this, scroll down to the day that you want to copy. Press  and select “Copy”.

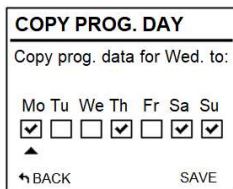

Select the days you want to copy the programme to.

Scroll down to “Save”, press  and the copy of the programme will have finalised.

If you want this setting to be stored as a preset programme, select “Save” in the next screen.

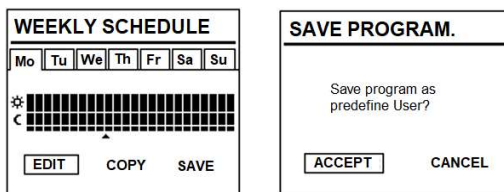

Press  and a new preset programme will be generated with the name USER, which you can see and select at any time in the “Preset Programmes” menu.

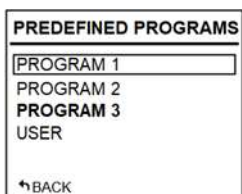

The selected option will be highlighted in bold.

The option "USER" will only appear, in case a personalized programming has been previously saved.

 *Ecobi PRO will not charge at intervals set to Frost Protection ☼. It is recommended to reserve this temperature level solely for complete days on which you do not require heating.*

3.4. Charge setting

The Charge Setting menu allows you to change the factory preset charging period of your storage heater to match the off-peak period of your hourly tariff, as well as the days of the week on which you need the storage heater to charge. The standard factory preset period is 00:00 to 08:00 and the charge is active every day of the week.

CHARGE CONFIG.
CHARGE PERIODS
CHARGE DAYS
INITIAL CHARGE
←BACK

3.4.1 Charging periods

Go into the “Charging Periods” menu if you want to change the charging periods for your device.

2 charging periods are selected in Ecombi PRO.

- **1st charging period:** Factory setting of 00:00 to 08:00.
- **2nd charging period:** (Factory disabled, 00:00 to 00:00).

CHARGE CONFIG.	Start	End
PERIOD 1:	00:00	07:00
PERIOD 2:	Disable	
←BACK		

The factory setting for both periods can be changed as you wish. Enter the period that you want to alter and change the start and end time to adapt to your tariff.



The factory charging period will be from 22:00 to 12:00 in winter and from 23:00 to 13:00 in summer, if the nominal charging time of 14 hours is activated in the Advanced Settings menu (See section 3.5. Advanced Settings).

3.4.2 Charging days in the week

CHARGE DAYS						
Set charging periods on:						
Mo	Tu	We	Th	Fr	Sa	Su
<input checked="" type="checkbox"/>	<input type="checkbox"/>	<input type="checkbox"/>	<input checked="" type="checkbox"/>	<input type="checkbox"/>	<input checked="" type="checkbox"/>	<input checked="" type="checkbox"/>
←BACK						SAVE

It is possible to select the days of the week on which the Ecombi PRO heater will charge and those on which it will not. Access the “Charging Days” menu and select the days on which you want the storage heater to charge.



If a day of the week is selected as a non-charging day, the Ecombi PRO heater automatically sets the Frost Protection setpoint for this day in the Programme mode and automatically assigns this temperature to the 24 hours of the non-charging day in the Basic mode.

3.4.3 Initial charge

The initial factory setting charge is 100%. It is the charge value of the device at the start of an extended period of inactivity or from its installation. Subsequently, during its operation, the device self-regulates the day-to-day level of charge so that it operates efficiently in accordance with energy needs.

To change the charge percentage, from the “Initial Charge” menu, go into “Edit”, select the desired charge value and select “Save”.



If the balancing heating element is disabled, Ecombi PRO will not automatically calculate the day-to-day charge and will always retain the maximum charge value that has been set in the initial charging parameter as the target charge.

3.5. Advanced settings

With the advanced settings menu, you can change general settings in the device, as well as its advanced operating settings. To access the advanced settings menu, press  for 5 seconds and then select the “Advanced” menu. The Advanced Settings menu comprises the following parts:

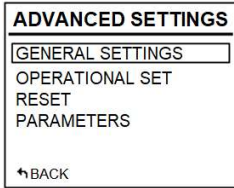

- General settings.
- Operating settings.
- Reset.
- Parameters (Reserved for installer and factory settings. Any change can alter the behaviour of the device).

3.5.1 General settings

- **LANGUAGE:** Select the language that you want.
- **UNITS:** Choose between “Celsius” and “Fahrenheit”, according to the temperature unit that you want.
- **AUTOMATIC TIME CHANGE:** Activate or disable the automatic time change, from winter to summer and vice-versa.
- **AMPLIFIER:** Activate or disable the sound of the keystrokes on the keyboard.
- **SCREEN:**
 - **Time on:** selects the time it takes for the display to turn off after you stop using the keyboard.
 - **Brightness activated:** selects the percentage of brightness when the screen is on.
 - **Brightness disabled:** selects the percentage of brightness when the screen is off.
 - **Style:** select the screen design style.
 - Light B/W: white background and black letters.
 - Dark B/W: black background and white letters.
 - Colour: Home screen with coloured icons.

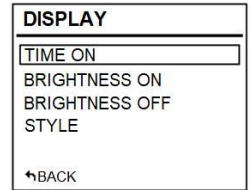

3.5.2 Operating settings

- **BLANCING HEATING ELEMENT:**
 - **Status:** Balancing heating element active or inactive.
 - **Maximum peak times:** Maximum operating time of the balancing heating element during tariff on-peak periods. Set this value to “0” to disable the operation of the balancing heating element in tariff on-peak periods; in this case the charge correction will not work and the same level of charge will apply to every day. (Factory setting: 5 hours for nominal charge of 8 hours, 3 hours for nominal charge of 14 hours).
 - **Weekend restriction:** Restricted operation of the balancing heating element at weekends. If this is activated, the restriction set in “Maximum peak times” for the maximum operating times also applies to weekends. If it is disabled, this restriction does not apply to weekends. (Factory setting: On). *Only available if the device is set to 8 hours nominal charging time.*
- **FROST PROTECTION:** Activate or disable the frost protection mode if the device is operating in Off mode.
- **OVERLOAD PROTECTION:** Protection against excessive temperature whilst charging. Degrees above the comfort setpoint at which the storage heater stops charging. (Selectable values 0,1,2,3,4 and 5).

- **CONTROL TYPE:** Select the temperature control type. A PID device with default settings programmed is recommended.
- **OPEN WINDOW DETECTION:** Activates when open windows detected (On/Off).
- **INTELLIGENT START-UP:** Adaptable start-up activation (On/Off).
- **COMPENSATION:** Correction of room temperature (Values from -5°C to 5°C).
- **NOMINAL CHARGE:** Ecombi PRO can operate with hourly discrimination tariffs of 8 or 14 off-peak hours. Set the device for 8 or 14 hours according to the number of off-peak hours of your tariff.

3.5.3 Reset and default factory settings

You can reset the unit and restore factory setting configuration.

Default Values



Parameter	8 hours setting	14 hours setting
Sun: Comfort temperature ☀	21°C	21°C
Moon: Economic temperature 🌙	18°C	18°C
Frost protection temperature ❄	3°C	3°C
UP01: Initial % of storage charge	100%	100%
UP02: Starting time off peak period 1	00:00	22:00
UP03: Ending time off peak period 1	08:00	12:00
UP04: Starting time off peak period 2	00:00	00:00
UP05: Ending time off peak period 2	00:00	00:00
UP06: Charging days of the week	Charging 7 days of the week.	Charging 7 days of the week.
UP07: Ambient sensor Offset	0°C	0°C
UP08: Max. Balancing element – working period	5 hours	3 hours
UP09: Overtemperature protection	2°C	2°C
UP10: Temperature Unit	°C	°C
UP11: Open Window Detection Function	Off	Off
UP12: Adaptive Start Control	Off	Off
UP13: Kind of temperature control	PID	PID
UP14: Weekend Balancing Element restriction	On	N/A



Incorrect time settings, erroneous programming of the reduced rate time and too high temperature settings may result in a high cost of your electricity bill.

3.6. Emitter Mode

This operation mode is used when it is necessary to heat the room temporarily and there is no need for storage heating. To set this mode, turn off the unit by pressing the main switch on the back-side panel and keep pressed  at the same time you turn on the unit by pressing the main switch until the message I9.0E is displayed on the display.

- Emitter mode is a temporary operation mode. You cannot access from this mode to general setting menu, operation mode menu or any other settings.
- Use  and  to modify the set-point temperature for this operation mode. The unit will turn on the balancing heating element if required in order to provide instantaneous heat to the room.
- The unit will not charge within this mode.

To exit emitter mode and go back to the common operation mode, just turn off and turn on the unit again by pressing the main switch on the back-side panel.



4.- REMOTE OPERATION USING THE G-CONTROL HUB

It is possible to control the full operation of the unit remotely with the Elnur Gabarron Wifi Control app or the app-web (<https://remotecontrol.elnur.es>). The unit must be connected to a G-Control Hub connected to the internet to use this feature.

To associate the ECOMBI PRO unit to the G-Control Hub, follow the instructions of the installation wizard of the app.

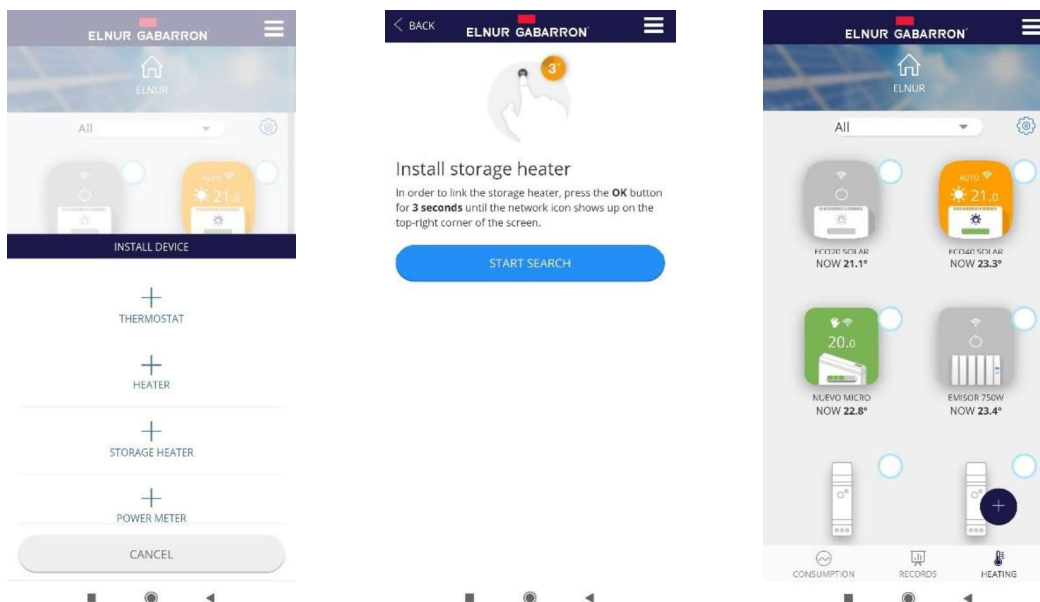

- Open the application and login with your user and password.
- Access the heating menu in the top menu in the app.
- Press the button (+) and select the type of heater that you are going to connect (Storage heater).
- Press Start Search and follow the instructions of the installation wizard.



When required, keep pressed  button during 3 seconds until the symbol  is displayed in the storage heater display.

You can control now and adjust the settings of your storage heater using the Elnur Gabarron Wifi Control app or the app-web <https://remotecontrol.elnur.es>.

5.- TROUBLESHOOTING

<p>ECOMBI PRO does not heat.</p>	<p>Please check it is connected and switched on. Make sure the device is not covered or the lower air inlets are not obstructed. The LR safety limit may be activated; in this case it is necessary to reset it manually. Please contact technician.</p>
<p>ECOMBI PRO does not reach set up temperature</p>	<p>Make sure that adequate temperature is selected. Make sure the storage heater is sized correctly for heat loss.</p>
<p>Error messages in display</p>	<p>Please contact technician.</p>
<p>ECOMBI PRO does not communicate with the G Control Hub.</p>	<p>Check the unit is associated, the symbol  must be shown on the display. For distances greater than 30 metros and 2-3 walls, associate first the closest units. Each unit can work as signal extender. If  symbol is flashing, check the G Control Hub connexion to the network, and if any other device in the RF Net that could be working as signal extender has been removed.</p>

6.- CLEANING MAINTENANCE INSTRUCTIONS

Before cleaning, make sure the power has been turned off at the circuit breaker panel and that the heating element of the heater is cool.

Occasionally, clean dust with a dry, soft cloth. Do not use any solvent or abrasive product for cleaning.

When the Heating season is finished, please disconnect the device by turning off the power switch located at the right back of the unit or at the circuit breaker.

Any other servicing should be performed by an authorized technician.



ECOMBI PRO has been manufactured under a fully assured quality system and using environmentally friendly processes. Once its useful life is finished please take the device to a recycling depot so that its components can be recycled in an appropriate way.

7.- MAIN COMPONENTS LIST

Storage Heating Element (All except ECO15 PRO)	Ref. 15190091	Power PCB & Fixing Bracket	Ref. 15191890
Storage Heating Element (ECO15 PRO)	Ref. 15190875	Keyboard PCB ECO PRO	Ref. 15192680
350W Balancing Heating Element (ECO15/20 PRO)	Ref. 15190111	Room Sensor	Ref. 46102195
450W Balancing Heating Element (ECO30 PRO)	Ref. 15190121	110°C Balancing Element Limiter	Ref. 15190725
600W Balancing Heating Element (ECO40 PRO)	Ref. 15190131	135°C Cut Out Manually Limiter	Ref. 10190460
Switch	Ref. 15190055	PT1000 Core Sensor	Ref. 15192140

8.- THECNICAL FEATURES

	ECO15 PRO	ECO20 PRO	ECO30 PRO	ECO40 PRO
Connection	220 - 240V ~	220 - 240V ~	220 - 240V ~	220 - 240V ~
Balancing Element Output	350W	350W	450W	600W
Insulation	Class I	Class I	Class I	Class I
Length	55cm	66cm	89cm	111cm
Height	73cm	73cm	73cm	73cm
Depth	18cm	18cm	18cm	18cm
Weight	59kg	77kg	112kg	147kg
Number of bricks	4	8	12	16
Brick Package	11072	11016	11016	11016
	8 Hours Configuration			
Storage Heater Output	975W	1300W	1950W	2600W
Charge Period	8h	8h	8h	8h
Charging	7.8 kWh	10.4 kWh	15.6 kWh	20.8 kWh
	14 Hours Configuration			
Storage Heater Output	975W	650W	1300W	1300W
Charge Period	14h	14h	14h	14h
Charging	9.5 kWh	9.1 kWh	15.5 kWh	18.2 kWh



Storage heater elements and balancing heating element will never operate at the same time.

EN



The symbol on the product or in its packaging indicates that this product may not be treated as household waste. Instead it shall be handed over to the applicable collection point for the recycling of electrical and electronic equipment. By ensuring this product is disposed of correctly, you will help prevent potential negative consequences for the environment and human health, which could otherwise be caused by inappropriate waste handling of this product. For more detailed information about recycling of this product, please contact your local city office, your household waste disposal service or the shop where you purchased the product. These instructions are only valid in the EU member states.



ELNUR GABARRON®

ELNUR S.A.

Travesía de Villa Esther, 11
28110 Algete - Madrid

Tfno. Atención al Cliente:
+34 91 628 1440

www.elnurgabarron.es
www.elnurgabarron.com



ER-0706/1999



GA-2002/0284

